

Sealings for pressure measuring instruments Model 910.17

WIKA data sheet AC 09.08

Applications

- For sealing the process connections of pressure measuring instruments and fittings with parallel threads

Special features

- Various materials and sizes
- Various versions:
 - WIKA sealings
 - Sealing washers per EN 837-1 (and similar)
 - Special sealings
 - Edged sealing rings

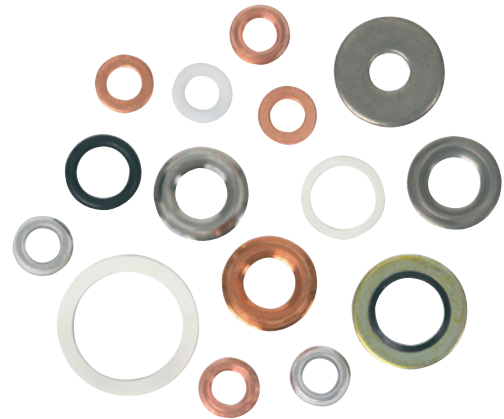

Model 910.17 sealings from various materials and sizes

Description

These contact seals for static sealing surfaces achieve their effect through a high-enough surface pressure between the two threaded connections. The sealings are used to seal the process connections on pressure measuring instruments at measuring points and connection components in process equipment and piping assemblies (e.g. valves, shut-off valves, syphons, connectors, overload protection devices). They prevent the accidental leakage of gaseous or liquid media into the environment.

We recommend that every time a pressure measuring instrument is changed, the sealing is checked for damage or deformation and, if necessary, replaced with a new sealing.

WIKA sealings

It is already well known that screwing in pressure measuring instruments, valves and other fittings using the usual flat gasket from soft metal or non-ferrous metals often presents difficulties. The threaded connections should be made tight, while at the same time the components to be combined should be able to be set to the required position with respect to each other.

The pressure measuring instrument and valve will not be readable in the required direction, or sealing will not be achieved fully in the ideal orientation.

Unscrewing, several changes and shimming of different thicknesses of flat gaskets will then be the consequence.

WIKA solution

With WIKA sealings, it is possible to orientate the pressure measuring instrument to the desired position by turning as much as one full turn once the seal has been made.

WIKA sealings from stainless steel achieve, as a result of their special form and the higher strength of their material, an excellent sealing quality after only a slight turn, while a further rotation up to approx. ½ turn is possible for orientation.

Design variants

■ Form 1

For self-centering on the centering spigot in accordance with EN 837-1

■ Form 2

For centering in the bore hole, intended for pressure gauge connectors not featuring a spigot or sealing face.

Installation example

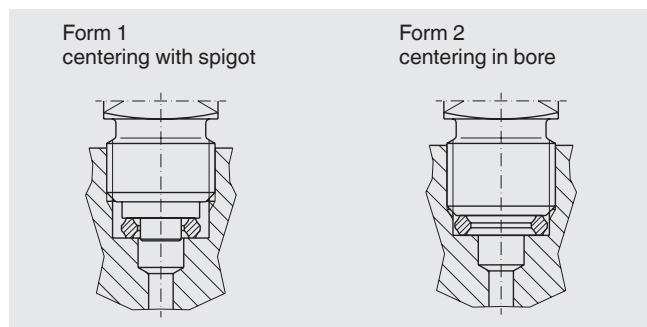

Dimensions in mm

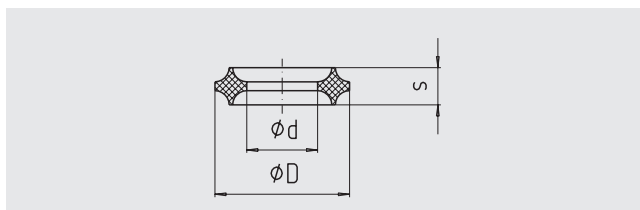

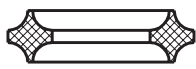
Design	Thread size	Material	Dimensions in mm			Form	Order no.
			D +0.2	d -0.2	s		
	G 1/8	Cu	8 + 0.1	4.1 + 0.1	2.7	1	9090789
	G 1/4, M12 x 1.5	Al	9.3	5.4	3.2	1	9090797
	G 1/4, M12 x 1.5	Cu	9.3	5.4	3.2	1	9090800
	G 1/4, M12 x 1.5	1.4571	9.3	5.4	3.2	1	9092161
	G 3/8, G 1/2, M20 x 1.5	Cu	14.8	8	4.2	1	9090819
	G 3/8, G 1/2, M20 x 1.5	1.4571	14.8	8	4.2	1	9092099
	G 1/4	Al	11	5.5	3.2	2	9092269
	G 1/4	Cu	11	5.5	3.2	2	9092277
	M12 x 1.5	Cu	9.8	5.5	3.2	2	9092285
	G 1/2	Cu	18.2	11	4.2	2	9092293

Sealing washers per EN 837-1 (and similar)

The sealing washers are intended for the sealing of pressure measuring instruments and their corresponding fittings. The dimensions of the sealing washers comply with the EN 837-1 connection standard and they are available in copper (Cu), nickel (Ni), asbestos-free Novapress 300 (NP uni) sealing material and plastic (PTFE).

The 0.5 mm thick PTFE sealing washer is primarily intended for fitting with diaphragm gauges with threaded connections, whose wetted parts are protected against aggressive media by a PTFE lining. If metal sealings are used, there is a risk of the PTFE lining being damaged.

The 2.0 mm thick PTFE washers are mainly used for pressure measuring instruments and diaphragm seals for the food industry, where the wetted parts are generally from stainless steel.

Dimensions in mm

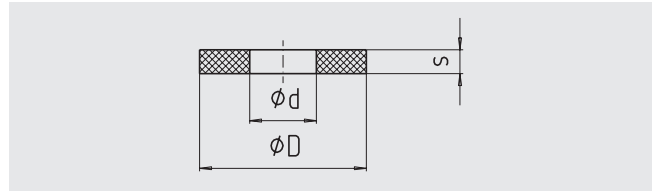

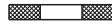
Design	Thread size	Material	Dimensions in mm			Order no.
			D	d	s	
	G 1/4 ¹⁾	Cu	9.5	5.2	1.5	9091424
	G 1/4 ¹⁾	NP uni	9.5	5.2	1.5	9091432
	G 1/2 ¹⁾	Cu	17.5	6.2	2	9091440
	G 1/2	NP uni	17.5	6.2	2.5	9091459
	G 1/2 ¹⁾	Ni	17.5	6.2	2	9091467
	G 1/4	PTFE	9.5	5.2	0.5	9092080
	G 1/2	PTFE	17.5	6.2	0.5	9091173
	G 1/2	PTFE	17.5	7	2	9091505

1) corresponds to EN 837-1

Special sealings

For the fitting of pressure measuring instruments with G 3/4 B connections with lens-type sealing rings (e.g. together with threaded flanges, No. 90911165, data sheet AC 09.05) a lens-type sealing ring in accordance with EN 837-1 is available.

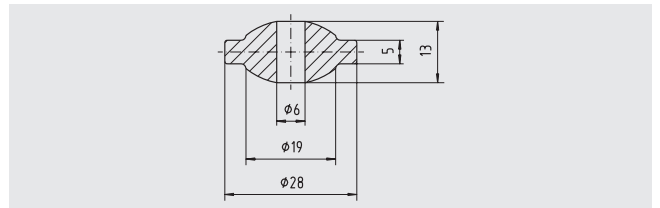

Design	Thread size	Material	Standard	Order no.
Lens-type sealing ring	G 3/4	St	EN 837-1	9091483

Edged sealing rings

Edged sealing rings are generally fitted together with solder-free connection fittings with compression rings and are included in the scope of supply for these. The edged sealing rings offered here are intended mainly for replacements.

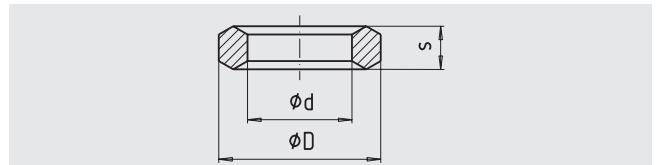

Design	Thread size	Material	Dimensions in mm			Order no.
			D	d	s	
	G 1/4	St	11.3	6	4.5	9092234
	G 1/2	St	18.5	12	5	9092242
	G 1/2	1.4571	18.5	12	5	9092250

Ordering information

To order, the 7-digit order number is sufficient. Other options require additional specification.

© 2004 WIKA Alexander Wiegand SE & Co. KG, all rights reserved
The specifications given in this document represent the state of engineering at the time of publishing.
We reserve the right to make modifications to the specifications and materials.

